

**Nr. 90 Winkel 90° Rotguss 1
1/2" Innengewinde 16bar
(0720206)**



REBER
Bewässerungssysteme

TECHNISCHE DATEN

Werkstoff	Rotguss
Anschluss	Innengewinde
Fitting Nr.	Nr. 90
Maß	1 1/2"
Arbeitsdruck	16 bar

ABMESSUNGEN

Cb-1	27 mm
Cb-2	27 mm
ØDi-1	1 1/2 "
ØDi-2	1 1/2 "
β	90 °

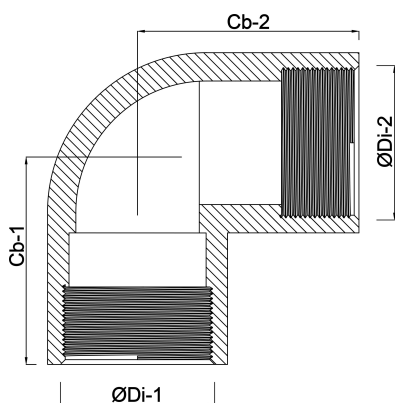

Generiert am: 13.03.2026

Reber Beregnung GmbH
Gottlieb Daimler Str. 2
67227 Frankenthal
Deutschland
+49 (0) 6233 3772 - 0
info@reberberegnung.de
<http://www.reberberegnung.de>



REBER
Bewässerungssysteme