

Profec Kugelhahn PVC-U 16 mm Klebemuffe 16bar DN15 Grau Typ Safe 600 (0112100)



REBER
Bewässerungssysteme

DN

15

ABMESSUNGEN

Ct-1 46 mm

Lb 84 mm

R 35 mm

ØDf 10 mm

ØDi-1 16 mm

ØDi-2 16 mm

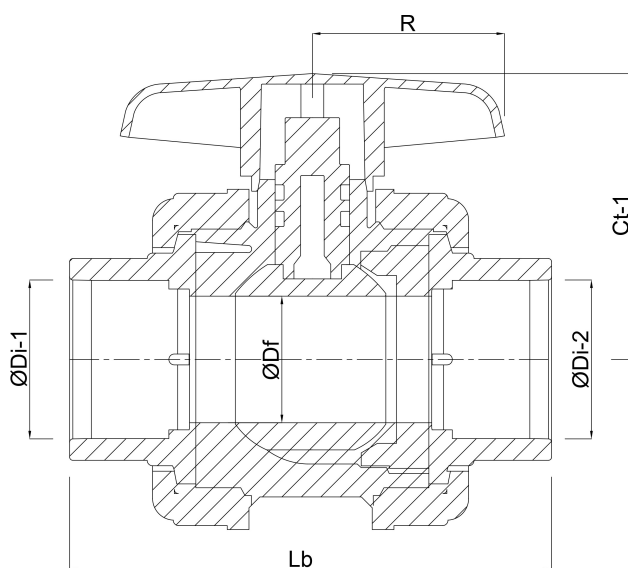

PRODUKTINFORMATIONEN

Mit gesicherter Kugel.



REBER
Bewässerungssysteme

Generiert am: 23.05.2026

Reber Beregnung GmbH
Gottlieb Daimler Str. 2
67227 Frankenthal
Deutschland
+49 (0) 6233 3772 - 0
info@reberberegnung.de
<http://www.reberberegnung.de>



REBER
Bewässerungssysteme