

Profec Verschraubung PVC-U 40 mm Klebemuffe 10bar Grau (0110074)



REBER
Bewässerungssysteme

TECHNISCHE DATEN

Farbe Grau

Werkstoff PVC-U

Material Dichtung NBR

Anschluss Klebemuffe

Maß 40 mm

Länge 71 mm

Arbeitsdruck 10 bar

ABMESSUNGEN

Do-n 71 mm

L 71 mm

Lb 41 mm

Lb-2 30 mm

ØDi-1 40 mm

ØDi-2 40 mm

ØDo-1 52 mm



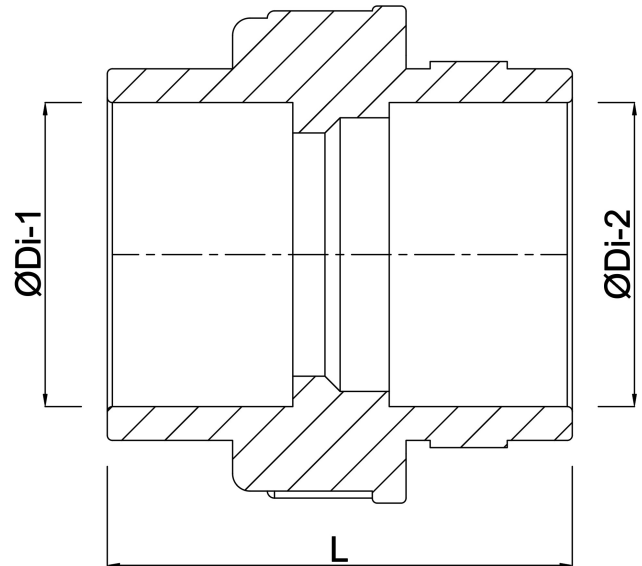

Generiert am: 22.05.2026

Reber Beregnung GmbH
Gottlieb Daimler Str. 2
67227 Frankenthal
Deutschland
+49 (0) 6233 3772 - 0
info@reberberegnung.de
<http://www.reberberegnung.de>



REBER
Bewässerungssysteme