

Profec Kugelhahn PVC-U 63 mm Klebemuffe 16bar DN50 Grau Typ Safe 600 (0112106)



REBER
Bewässerungssysteme

TECHNISCHE DATEN

Farbe Grau

Typ Safe 600

Werkstoff PVC-U

Bedienung Hebel

Griff-Farbe Rot

Material Hebel/Griff PVC-U

Gehäusekonstruktion 3-teilig

Material Kugel PVC-U

Material Spindel PVC-U

Material Gehäuse PVC-U

Material Dichtung hytrel/EPDM

Anschluss Klebemuffe

Max. Temperatur 60 °C

Minimale Mediumtemperatur 0 °C
(kontinuierlich)

Arbeitsdruck 16 bar

Maß 63 mm



DN

50

ABMESSUNGEN

Ct-1

107 mm

Lb

190 mm

R

74 mm

ØDf

50 mm

ØDi-1

63 mm

ØDi-2

63 mm

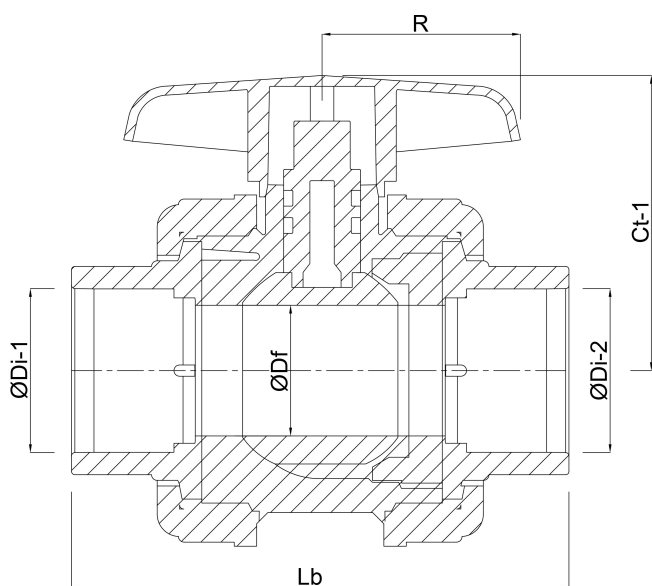

PRODUKTINFORMATIONEN

Mit gesicherter Kugel.



REBER
Bewässerungssysteme

Generiert am: 17.04.2026

Reber Beregnung GmbH
Gottlieb Daimler Str. 2
67227 Frankenthal
Deutschland
+49 (0) 6233 3772 - 0
info@reberberegnung.de
<http://www.reberberegnung.de>



REBER
Bewässerungssysteme