

Blindflansch Edelstahl 316
DN125 DIN Flansch 16bar
DN125 PN16 (0080661)



REBER
Bewässerungssysteme

TECHNISCHE DATEN

Werkstoff Edelstahl 316

Anschluss DIN Flansch

DIN Norm DIN 2527

Flansch PN16

Arbeitsdruck 16 bar

Maß DN125

DN 125

Außen ø 250 mm

Gewicht 8.1 kg

Dicke 22 mm

Loch ø 18 mm

Löcher 8

ABMESSUNGEN

O 18 mm

PCD 210 mm



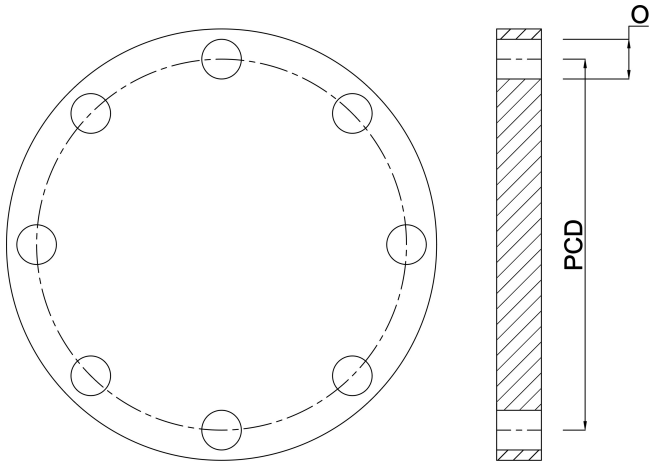

Generiert am: 13.03.2026

Reber Beregnung GmbH
Gottlieb Daimler Str. 2
67227 Frankenthal
Deutschland
+49 (0) 6233 3772 - 0
info@reberberegnung.de
<http://www.reberberegnung.de>



REBER
Bewässerungssysteme