

**Profec Übergangsadapter PVC-
U 32 mm x 1" Klebemuffe x
Imperial Klebemuffe 16bar
Grau (0169903)**



REBER
Bewässerungssysteme

TECHNISCHE DATEN

Farbe	Grau
Werkstoff	PVC-U
Anschluss	Klebemuffe x Imperial Klebemuffe
Arbeitsdruck	16 bar
Maß	32 mm x 1"

ABMESSUNGEN

L	47 mm
P-1	22.5 mm
P-2	22.5 mm
ØDi-1	32 mm
ØDi-2	1 "

Generiert am: 13.03.2026

Reber Beregung GmbH
Gottlieb Daimler Str. 2
67227 Frankenthal

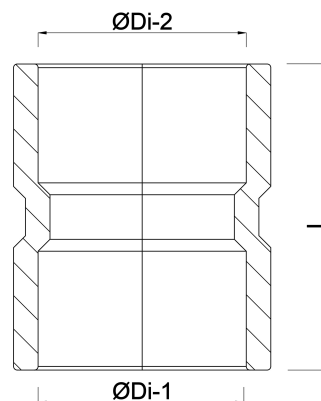

REBER
Bewässerungssysteme

Deutschland
+49 (0) 6233 3772 - 0
info@reberberegnung.de
<http://www.reberberegnung.de>



REBER
Bewässerungssysteme