

**DAB Mehrstufige
Kreiselpumpe Edelstahl DN80
DIN Flansch 26.7A 400VAC Typ
NKV 45/4 T (7043209)**



REBER
Bewässerungssysteme

TECHNISCHE DATEN

Werkstoff Edelstahl

Anschluss DIN Flansch

Typ NKV 45/4 T

Leistung 20 PS

Maß DN80

Spannung 400VAC

Leistung 15 kW

Ampere 26.7 A

ABMESSUNGEN

C 242 mm

D 365 mm

H 1448 mm

H-1 140 mm

H-2 943 mm



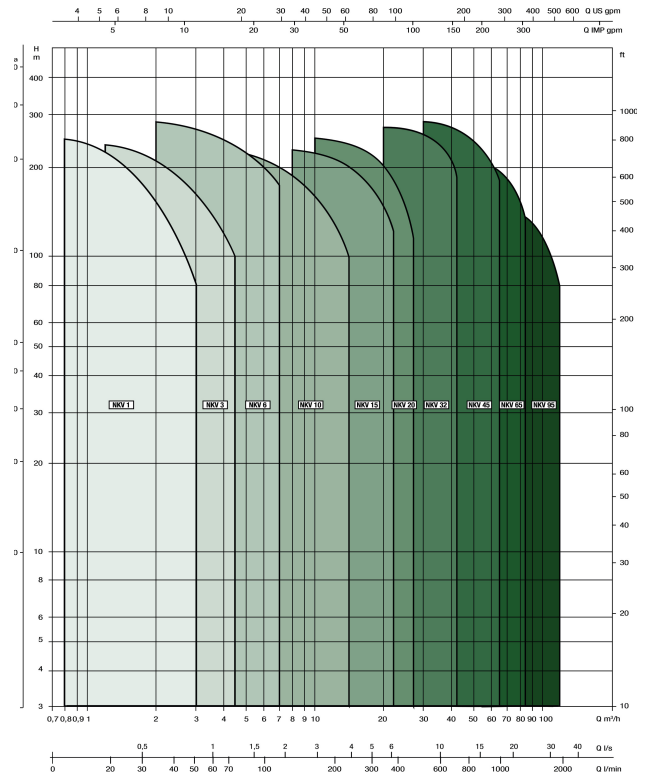
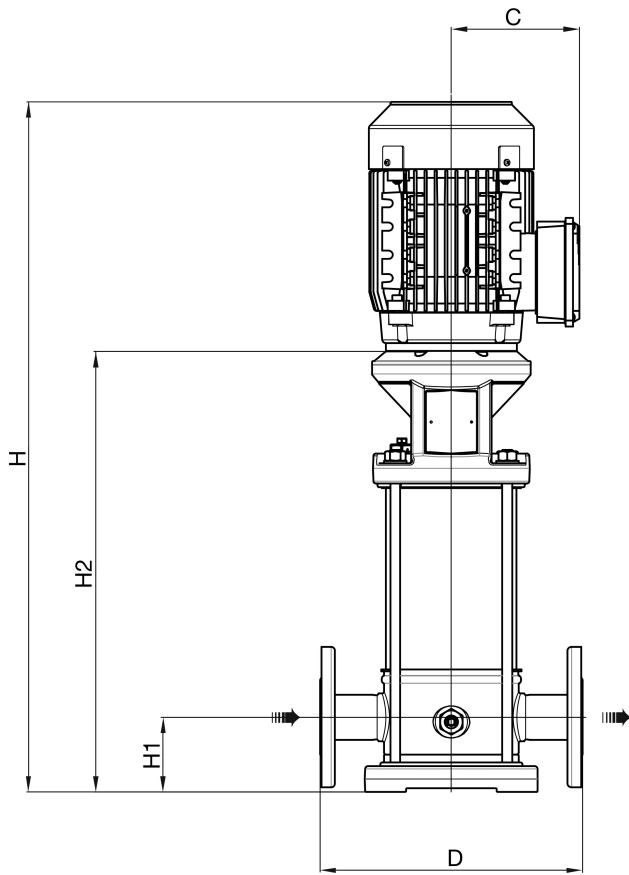

Generiert am: 27.05.2026

Reber Beregnung GmbH
 Gottlieb Daimler Str. 2
 67227 Frankenthal
 Deutschland
 +49 (0) 6233 3772 - 0
info@reberberegnung.de
<http://www.reberberegnung.de>



REBER
 Bewässerungssysteme