

**Profec Übergangsadapter PVC-
U 63 mm x 2" Klebemuffe x
Imperial Klebemuffe 16bar
Grau (0169906)**

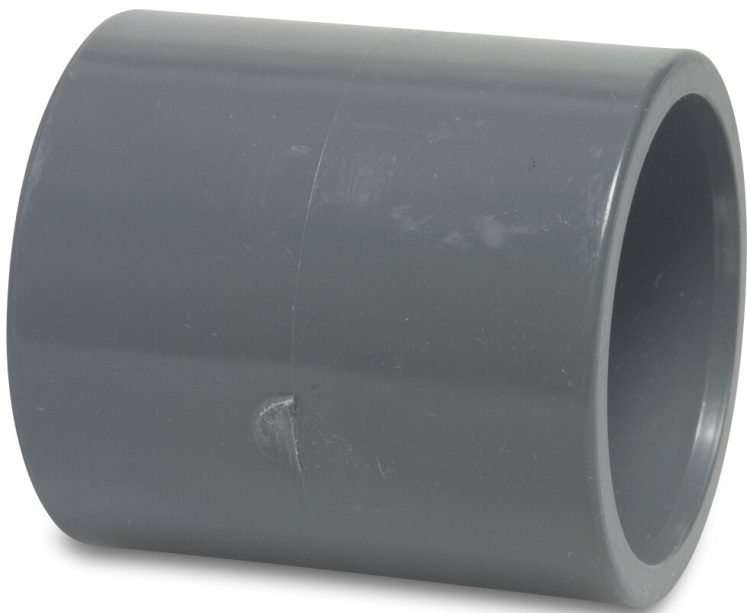

REBER
Bewässerungssysteme

TECHNISCHE DATEN

Farbe	Grau
Werkstoff	PVC-U
Anschluss	Klebemuffe x Imperial Klebemuffe
Arbeitsdruck	16 bar
Maß	63 mm x 2"

ABMESSUNGEN

L	79 mm
P-1	38 mm
P-2	38 mm
ØDi-1	63 mm
ØDi-2	2 "





Generiert am: 23.05.2026

Reber Beregnung GmbH
Gottlieb Daimler Str. 2
67227 Frankenthal
Deutschland
+49 (0) 6233 3772 - 0
info@reberberegnung.de
<http://www.reberberegnung.de>



REBER
Bewässerungssysteme