

Profec Nr. 2 Bogen 90° Messing 1" Innengewinde 40bar (0710280)



REBER
Bewässerungssysteme

TECHNISCHE DATEN

Werkstoff	Messing
Anschluss	Innengewinde
Fitting Nr.	Nr. 2
Arbeitsdruck	40 bar
Maß	1"

ABMESSUNGEN

Cb-1	82 mm
Cb-2	82 mm
ØDi-1	1 "
ØDi-2	1 "
β	90 °

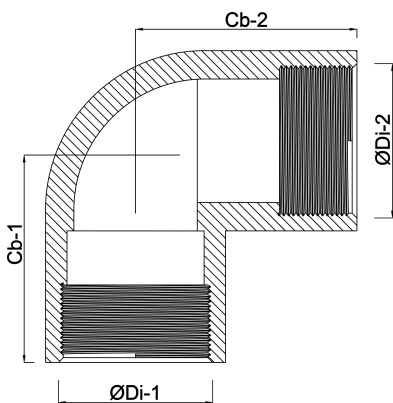

Generiert am: 13.03.2026

Reber Beregnung GmbH
Gottlieb Daimler Str. 2
67227 Frankenthal
Deutschland
+49 (0) 6233 3772 - 0
info@reberberegnung.de
<http://www.reberberegnung.de>



REBER
Bewässerungssysteme